





# HL03 – Horti Reina

## Horticulture



 **Niagara  
College  
Canada**

# Index

 About Us	03
 What We Offer?	04
 Niagara college business & commercialization innovation centre	05
 HL03 - Horti Reina	
> Introduction	06
> Key Fetures	07
> Product Specifications	08
> Product Dimensions	09
 Contact Us	10

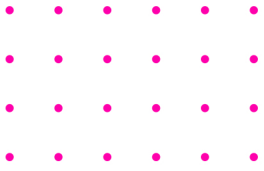

## About Us

We provide LED Lighting Solutions for farmers who do In door Farming, Vertical Farming, or Greenhouses Lumesmart's innovative LED products offer selection of colour and wavelength specific lights to promote growth in different produce varieties adjustable illumination intensity and helps to control dust keeping food fresh for longer Our energy-saving products are listed in the Ontario Made, and our DLC-certified products are allowing farmers to earn retrofit from the government.



## Our Vision

Making Peace by Saving Nature  
from the Effects of  
Global Warming



## Reducing carbon footprint by eco-friendly Lumesmart LED lighting

LumeSmart can help the greenhouse sector by providing energy-efficient and eco-friendly LED products. These solutions enable growers to reduce their carbon footprint and save on energy costs.

## Customized LED lighting solutions

LumeSmart can offer lighting systems custom-suited to the crop-specific needs of their clients, offering better performance compared to HPS lighting solutions of LED lighting systems



## Adjustable and personalized LED lighting solutions

Lumesmart LED systems offer customizable lighting solutions, through adjustable intensity and color spectrum, ideal for custom light formulations commonly known as 'light recipes'

## Government support through grants

The Federal and Provincial governments have both shown general support for the adoption of LED lighting systems as a method to reduce electricity consumption in the greenhouse industry. LumeSmart can leverage these grants to help offset the cost of switching to LED lighting making it a better financial decision for growers



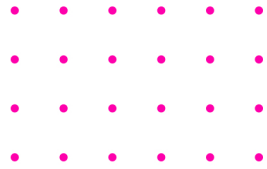

## Best Innovative LED Solutions for Your Horticulture Industry

---

We are providing the Best innovation solutions for Indoor Framing Greenhouses, Vertical Framing industries Based on our Research partnership with Niagara College Business & Commercialization Innovation Centre



Innovative Lighting Solutions  
Government Support



Professional Engineering Team  
After Sale Support





## HL03 – Horti Reina

Horti-Reina is a greenhouse supplemental intercanopy light being angled with respect to the horizontal, that 120° light is only accessible at the highest part of the crop because of the density of the leaves of the plant Intercanopy lighting spreads the light more evenly over the canopy and in the middle part of the crop which increases flower development

### System Efficacy

2.34  $\mu\text{mol}/\text{J}$  3.0  $\mu\text{mol}/\text{J}$

### Dimming

0~10 V Dimming

### IP Rating

IP65

### Certificate

ETL, CE, RoHs



## Key Features



- Daisy chain design helps save installation time and reduce total installation cost in commercial projects
- IP65 rated makes LED intercanopy operate well in greenhouse indoor or other high humidity environments
- Double-sided lighting design, minimizes light interception and keeps the lower canopy to get optimal and uniform light
- Inverted triangle structure minimizes the shadow on the plant canopy which is caused by the light from the top

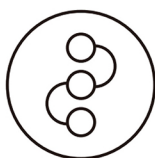

Daisy chain



IP65





## Product Specifications

Item No	HL03-75	HL03-150
Power	75 W	150 W
PAR Output	176 $\mu\text{mol/s}$ 225 $\mu\text{mol/s}$	351 $\mu\text{mol/s}$ 450 $\mu\text{mol/s}$
ePAR Output	194 $\mu\text{mol/s}$ 226 $\mu\text{mol/s}$	387 $\mu\text{mol/s}$ 452 $\mu\text{mol/s}$
AC Input Voltage	100-240 V AC / 100-277 V AC / 277-480 V AC, 50/60 Hz	
Radiation Angle	120°	
Net Weight	1.5 kg / 3.3 lbs	2.5 kg / 5.5 lbs
Gross Weight	7.0 kg / 15.4 lbs	12.0 kg / 26.5 lbs
	4 pcs per carton	
Dimensions	1380 x 65 x 69 mm (54.33" x 2.56" x 2.72")	2500 x 65 x 69 mm (98.43" x 2.56" x 2.72")

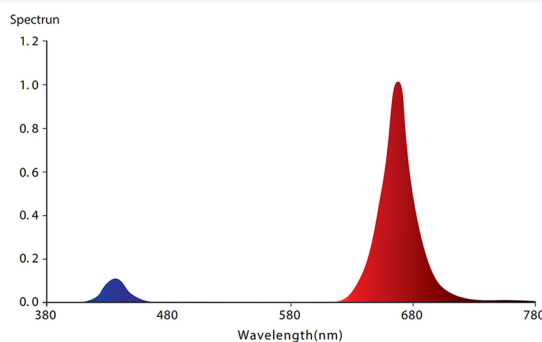
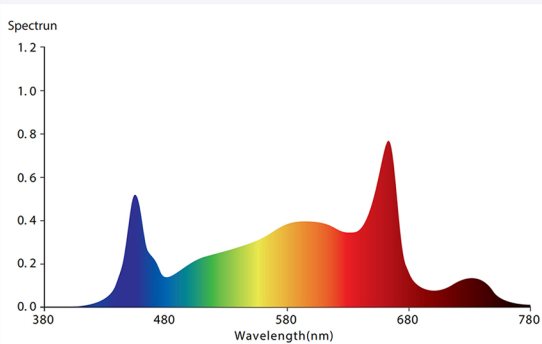
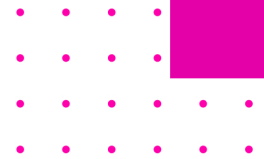

### Spectrum Solution

450nm blue light plays an important role in the early stage of plant growth and helps to establish a developed root system. With a peak wavelength of 730nm is designed to boost photosynthetic light levels in flowering stage, far red light will create a competitive response in plants, assisting in the formation of trichomes

HL03-P03-00 features two narrow spectral wavelength that maximize energy efficiency aiming to further reduce energy cost and operational expense



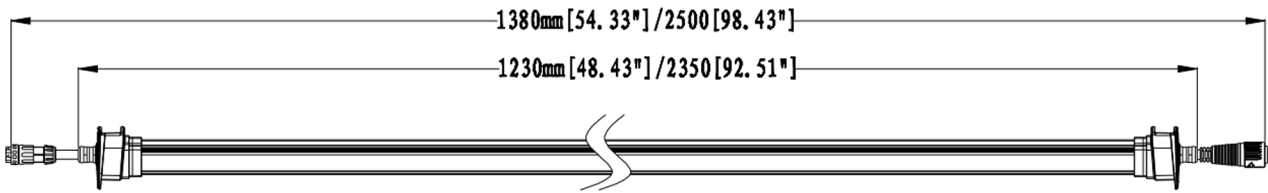
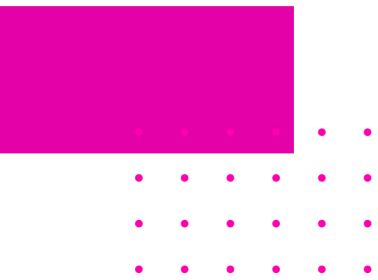

## Product Dimensions

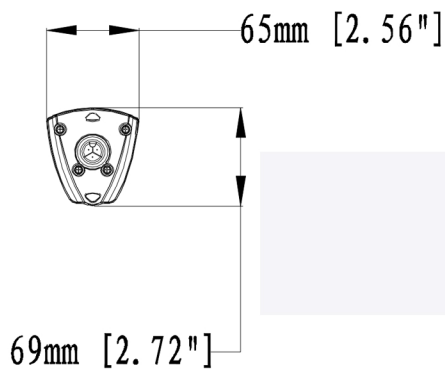



**CONTACT US**



✉ info@lumesmart.com

☎ +1- 4168876977

📍 Canada, Ontario, Richmond Hill

**01**

Project  
Planning

**02**

Research  
Analysis

**03**

Execute  
Project

**04**

Make it  
Happen

We Ensure Quality, Schedule and that We're All  
Working toward Same Goal